

Linear

MIMI A020 (20W)

Fixture Guide

KKDÖ

Indoor/Outdoor | Surface | Output up to 1840lm/m (561lm/ft)



26-92lm/W



Key applications

- ✓ Architectural detail
- ✓ Bathrooms
- ✓ Building facades
- ✓ Cove lighting
- ✓ Direct lighting
- ✓ Exterior
- ✓ Hand rail
- ✓ Indirect lighting
- ✓ Wet area

Key features

- ✓ A-line (High Efficacy)
- ✓ Adjustable
- ✓ Custom lengths
- ✓ Constant Voltage (CV)
- ✓ Diffusion: homogenous
- ✓ Direct view
- ✓ High lumen efficacy
- ✓ IP44 moisture resistant
- ✓ IP67 waterproof
- ✓ Nano louvre

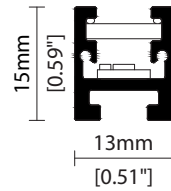

MOUNTING METHODS



KKCP-02 Clip



KKCP-14 Locking clip



KKBK-06 Fixed bracket



KKBK-05 Adjustable bracket



EB End Cap Bracket

Linear

MIMI A020 (20W)

Specification sheet



Dimensions	H15/W13/L97-2020mm* (H0.59/W0.51/L3.82-79.53in*) *Nano Louvre = 1020mm/40.16in Max
PCB Cut-point	38.46mm increment/2000mm max (1.51in increment/78.74in max*) *Nano Louvre = 1020mm/40.16in Max
LED Pitch	4.8mm - 208LED/m (0.19in - 64LED/ft)
Chip	A-line
Cover/Optics	Clear (75°)/Diffused (95°)/Nano louvre (35°)/Black (63°)
CCT	A-line: 2700K/3000K/3500K/4000K
LED binning	A-line: 3-step MacAdam ellipse
CRI	94
Lifetime	50,000 hours @ 25°C (50,000 hours @ 77°F)
Operating temp	T _a = -25 to 50°C (T _c max = 83.9°C) T _a = -13 to 122°F (T _c max = 183°F)
IP Rating	IP44/IP67
Finish	Silver anodised
Mounting	Surface mounting via clips or brackets
Power feed	Sheathed hardwire tails or male/female connectors
Control	0-10V/1-10V/DMX/DALI



LED Grading Key

Exclusive Grade *KKDC tuned CCT range
A-line* 3-step CCT range
 KKDC highest lumen efficacy LED

Power consumption	Supply voltage	Supply current
20W/m (6.10W/ft)	24V DC	0.83A/m (0.25A/ft)

Performance Data (3000K)

A-line	R1	R2	R3	R4	R5	R6	R7	R8	R9	R10	R11	R12	R13	R14
A-line	95	99	99	93	94	96	92	84	64	95	94	78	96	100

	Clear	Diffused	Diffused + Nano Louvre	Black	CRI	R9	Rf	Rg
A-line	1840lm/m (561lm/ft) 92lm/w	1500lm/m (457lm/ft) 75lm/w	520lm/m (158lm/ft) 26lm/w	760lm/m (232lm/ft) 38lm/w	94	64	-	-

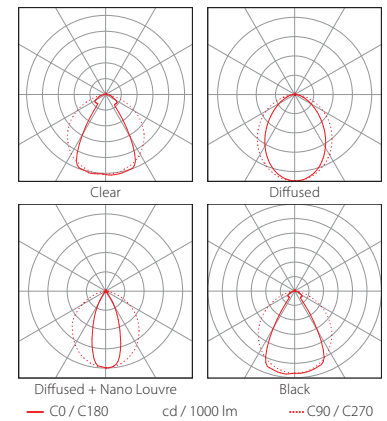
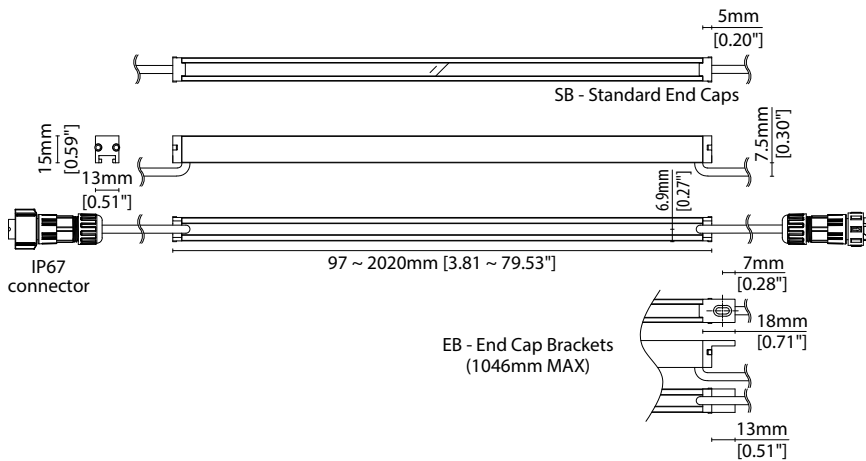

Data derived from independent UKAS/IESNA LM-79-08 accredited testing of production samples.

Linear

MIMI A020 (20W)

Code Table



FIXTURE

Model	Finish	Cover ¹	Grade ²	LED	Colour (CCT)	Length Availability ³	IP	Cable Length	Power Feed ⁴	Fixing	Input
MIMI MI	Silver Anodised	SA Clear Diffused Diffused + Nano Louvre ^{5,6} Black	B A- A	A020 020	2700K 27 3000K 30 3500K 35 4000K 40	m 97-2020mm 38.46mm increments i 3.82-79.53in 1.51in increments (Specify length code OR total run length)	IP44 44 IP67 67	300mm/11.81" 0300	Single ø4.3mm sheath tail S00A Double ø4.3mm sheath tail D00A Single ø4.3mm sheath IP67 connector S67A Double ø4.3mm sheath IP67 connector D67A	Standard End Cap SB End Cap Bracket EB	DC 24V g

¹ Refer to **Cover Options** on **Options** pages ² Refer to **LED Grading Key** on **Specification sheet** page ³ Refer to **Length Availability List** or enter total run length instead of length code
⁴ Refer to **Power Feed Options** on **Options** pages ⁵ Max length available with Nano Louvre is 1020mm
⁶ Nano Louvre suitable for IP44 variant ONLY. Prolonged exposure to water droplets on cover surface may result in superficial peeling of Nano louvre film without affecting integrity of housing ingress
⁷ Due to the clear, flush potted polyurethane top layer on IP67 MIMI a colour shift of +/-20K should be expected

Code Example:

MI	-	SA	-	C	-	A-	-	020	-	30	-	m	-	520	-	67	-	0300	-	S00A	-	EB	-	g
MIMI		Silver Anodised		Diffused		A-		A020		3000K		520mm		IP67		300mm/11.81"		0300		Single ø4.3mm sheath tail		End Cap Bracket		DC 24V

ACCESSORIES

Mounting Accessories

KKCP-02	Clip (1no.)
KKCP-52	Clip (500no.)
KKCP-14	Lock Clip
KKBK-06	Fixed bracket
KKBK-05	Adjustable bracket

* Refer to **Mounting accessories** on **Accessories** pages

Connection Accessories

CN67-2P-0300	IP67 2 PIN male & female 300mm/11.81" pair
CN67-2P-1000	IP67 2 PIN male & female 1000mm/39.37" pair
CN67-2P-3000	IP67 2 PIN male & female 3000mm/118.11" pair

* Refer to **Power feed** on **Accessories** pages

Exterior Junction Boxes

KKJB-07	IP67 Slim J-Box
KKJB-07R	Potting Resin for IP67 Slim J-Box

* Refer to **Exterior Junction Boxes** on **Accessories** pages

PSU/Driver

0-10V/1-10V/DALI/DMX

* Refer to **Driver/PSU Options** page for details or provide requirement and KKDC to offer the suitable option

LED ENGINE VARIANTS (LED STRIP TYPE)

Colour	LED	Lumen/m	Lumen/ft	W/m	W/ft	Spec Doc	Length	Increment
Single CCT	R007	475	145	7	2.13	MIMI R007	103-2020mm (4.05-79.53in)	41.7mm (1.64in)
	A010	920	280	10	3.05	MIMI A010	97-2020mm (3.82-79.53in)	38.46mm (1.51in)
	R014	979	299	14	4.27	MIMI R014	103-2020mm (4.05-79.53in)	41.7mm (1.64in)
	R020	1208	368	20	6.10	MIMI R020	103-2020mm (4.05-79.53in)	41.7mm (1.64in)
	A020	1840	561	20	6.10	MIMI A020	97-2020mm (3.82-79.53in)	38.46mm (1.51in)
Warm Dim/Dynamic White	R207	984	300	16	4.88	MIMI R207	103-2020mm (4.05-79.53in)	83.3mm (3.28in)
RGB	501	Red: 98 Green: 210 Blue: 35 RGB: 305	Red: 30 Green: 64 Blue: 11 RGB: 93	15.6	4.75	MIMI RGB	103-2020mm (4.05-79.53in)	83.3mm (3.28in)

* Performance data: A/s-line, clear cover, 3000K

Linear

MIMI A020 (20W)

Length Availability List



Length Code		Fixture Length ¹		LED Strip ²		End Cap Dimension		Wattage (W)	Output (lm)
Metric	Imperial(US)	Metric	Imperial(US)	Metric	Imperial(US)	Metric	Imperial(US)		3000K (Test Data)
m0097	i0004	97mm	3.82in	77mm	3.03in	10mm	0.39in	0.77	71
m0135	i0005	135mm	5.33in	115mm	4.54in	10mm	0.39in	1.15	106
m0174	i0007	174mm	6.84in	154mm	6.06in	10mm	0.39in	1.54	142
m0212	i0008	212mm	8.36in	192mm	7.57in	10mm	0.39in	1.92	177
m0251	i0010	251mm	9.87in	231mm	9.09in	10mm	0.39in	2.31	212
m0289	i0011	289mm	11.39in	269mm	10.60in	10mm	0.39in	2.69	248
m0328	i0013	328mm	12.90in	308mm	12.11in	10mm	0.39in	3.08	283
m0366	i0014	366mm	14.42in	346mm	13.63in	10mm	0.39in	3.46	318
m0405	i0016	405mm	15.93in	385mm	15.14in	10mm	0.39in	3.85	354
m0443	i0017	443mm	17.44in	423mm	16.66in	10mm	0.39in	4.23	389
m0482	i0019	482mm	18.96in	462mm	18.17in	10mm	0.39in	4.62	425
m0520	i0020	520mm	20.47in	500mm	19.69in	10mm	0.39in	5.00	460
m0558	i0022	558mm	21.99in	538mm	21.20in	10mm	0.39in	5.38	495
m0597	i0024	597mm	23.50in	577mm	22.71in	10mm	0.39in	5.77	531
m0635	i0025	635mm	25.02in	615mm	24.23in	10mm	0.39in	6.15	566
m0674	i0027	674mm	26.53in	654mm	25.74in	10mm	0.39in	6.54	602
m0712	i0028	712mm	28.04in	692mm	27.26in	10mm	0.39in	6.92	637
m0751	i0030	751mm	29.56in	731mm	28.77in	10mm	0.39in	7.31	672
m0789	i0031	789mm	31.07in	769mm	30.28in	10mm	0.39in	7.69	708
m0828	i0033	828mm	32.59in	808mm	31.80in	10mm	0.39in	8.08	743
m0866	i0034	866mm	34.10in	846mm	33.31in	10mm	0.39in	8.46	778
m0905	i0036	905mm	35.61in	885mm	34.83in	10mm	0.39in	8.85	814
m0943	i0037	943mm	37.13in	923mm	36.34in	10mm	0.39in	9.23	849
m0982	i0039	982mm	38.64in	962mm	37.86in	10mm	0.39in	9.62	885
m1020	i0040	1020mm	40.16in	1000mm	39.37in	10mm	0.39in	10.00	920
m1058	i0042	1058mm	41.67in	1038mm	40.88in	10mm	0.39in	10.38	955
m1097	i0043	1097mm	43.19in	1077mm	42.40in	10mm	0.39in	10.77	991
m1135	i0045	1135mm	44.70in	1115mm	43.91in	10mm	0.39in	11.15	1026
m1174	i0046	1174mm	46.21in	1154mm	45.43in	10mm	0.39in	11.54	1062
m1212	i0048	1212mm	47.73in	1192mm	46.94in	10mm	0.39in	11.92	1097
m1251	i0049	1251mm	49.24in	1231mm	48.46in	10mm	0.39in	12.31	1132
m1289	i0051	1289mm	50.76in	1269mm	49.97in	10mm	0.39in	12.69	1168
m1328	i0052	1328mm	52.27in	1308mm	51.48in	10mm	0.39in	13.08	1203
m1366	i0054	1366mm	53.79in	1346mm	53.00in	10mm	0.39in	13.46	1238
m1405	i0055	1405mm	55.30in	1385mm	54.51in	10mm	0.39in	13.85	1274
m1443	i0057	1443mm	56.81in	1423mm	56.03in	10mm	0.39in	14.23	1309
m1482	i0058	1482mm	58.33in	1462mm	57.54in	10mm	0.39in	14.62	1345
m1520	i0060	1520mm	59.84in	1500mm	59.06in	10mm	0.39in	15.00	1380
m1558	i0061	1558mm	61.36in	1538mm	60.57in	10mm	0.39in	15.38	1415
m1597	i0063	1597mm	62.87in	1577mm	62.08in	10mm	0.39in	15.77	1451
m1635	i0064	1635mm	64.39in	1615mm	63.60in	10mm	0.39in	16.15	1486
m1674	i0066	1674mm	65.90in	1654mm	65.11in	10mm	0.39in	16.54	1522
m1712	i0067	1712mm	67.41in	1692mm	66.63in	10mm	0.39in	16.92	1557

MIMI A020 (20W)

Length Availability List



Length Code		Fixture Length ¹		LED Strip ²		End Cap Dimension		Wattage (W)	Output (lm) 3000K (Test Data)
Metric	Imperial(US)	Metric	Imperial(US)	Metric	Imperial(US)	Metric	Imperial(US)		
m1751	i0069	1751mm	68.93in	1731mm	68.14in	10mm	0.39in	17.31	1592
m1789	i0070	1789mm	70.44in	1769mm	69.65in	10mm	0.39in	17.69	1628
m1828	i0072	1828mm	71.96in	1808mm	71.17in	10mm	0.39in	18.08	1663
m1866	i0073	1866mm	73.47in	1846mm	72.68in	10mm	0.39in	18.46	1698
m1905	i0075	1905mm	74.98in	1885mm	74.20in	10mm	0.39in	18.85	1734
m1943	i0076	1943mm	76.50in	1923mm	75.71in	10mm	0.39in	19.23	1769
m1982	i0078	1982mm	78.01in	1962mm	77.23in	10mm	0.39in	19.62	1805
m2020	i0080	2020mm	79.53in	2000mm	78.74in	10mm	0.39in	20.00	1840

¹ Actual total overall length of light fixture (LED strip + end caps + void/wire hole)

² Actual length of PCB strip

³ Actual length of 2x end caps

Standard End Caps (SB)

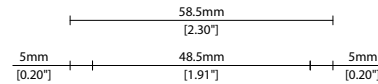

*End Cap Brackets (EB)
Increases overall standard
length by 26mm (2x13mm)

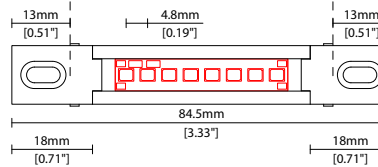

*1046mm MAX

***IMPORTANT NOTE:**
DUE TO POTENTIAL PROFILE 'SAGGING' THE MAX
LENGTH AVAILABLE WITH END CAP BRACKETS IS 1046mm.

Linear

MIMI A020 (20W)

Options

KKDC

COVER OPTIONS

* Options are an integral part of the fixture ordering codes. Please refer to **Code Table** pages.

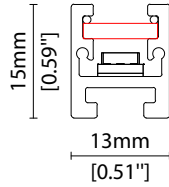

B Clear Cover
Polycarbonate
W13/H15mm (W0.51\"/>

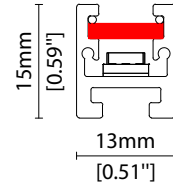

C Diffused Cover
Polycarbonate
W13/H15mm (W0.51\"/>

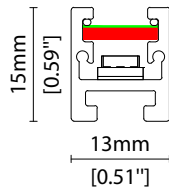

CN Diffused Cover + Nano Louvre
Polycarbonate cover with anti-glare, 30° cut-off view angle
W13/H15mm (W0.51\"/>

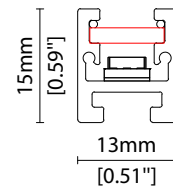

Y Black Clear Cover
Dark tinted translucent polycarbonate
60% light output
W13/H15mm (W0.51\"/>

END CAP OPTION

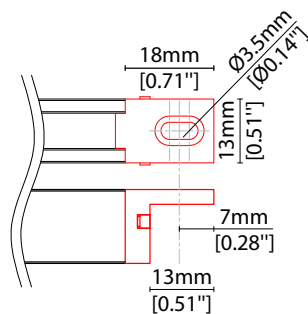

EB End Cap Bracket (Pair)
Handrail installation
Compatible up to 1m/40"
L18/W13/H15mm
(L0.7/W0.51/H0.59")

POWER FEED OPTIONS

0300 S00A 300mm (11.81") Single \varnothing 4.3mm sheath tail

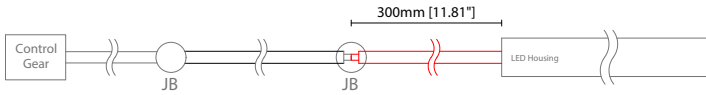

0300 D00A 300mm (11.81") Double \varnothing 4.3mm sheath tail

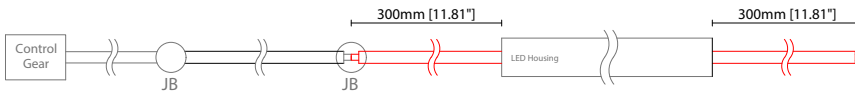

0300 S67A 300mm (11.81") Single \varnothing 4.3mm sheath connector IP67 (Premoulded)

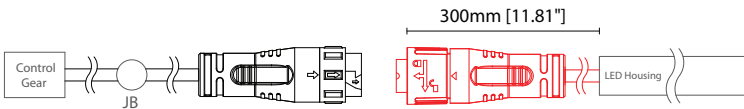

0300 D67A 300mm (11.81") Double \varnothing 4.3mm sheath connector IP67 (Premoulded)

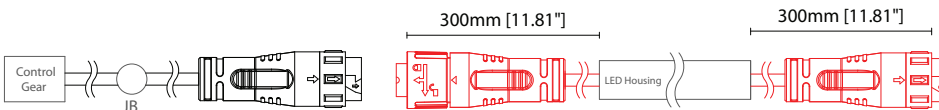

2 Pin Female Connector IP67 (Premoulded)

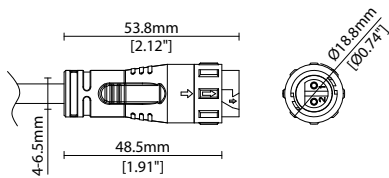

2 Pin Male Connector IP67 (Premoulded)

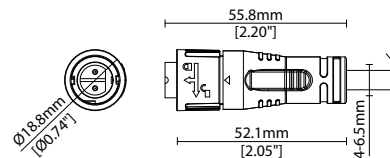

Key

Control Gear Power supply, sub-controllers & control systems

JB Junction box / cable connection

MOUNTING ACCESSORIES

Note: Accessories are to be ordered separately with corresponding code shown below.

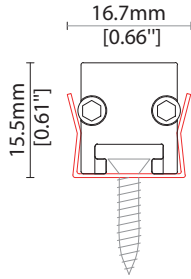

KKCP-02 (1no.)
KKCP-52 (500no.)
 Clip (allow 3 per metre/40in)
 S/Steel finish
 L25/W16.7/H15.5mm
 (L0.98/W0.66/H0.61")

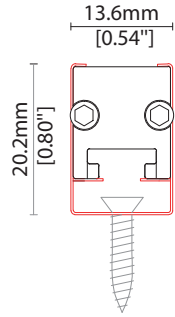

KKCP-14
 Lock clip (allow 2 per metre/40in)
 S/Steel finish
 L25/W14/H21mm
 (L0.98/W0.55/H0.83")

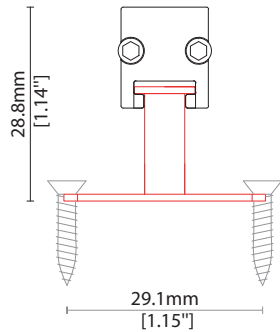

KKBK-06
 Fixed bracket (allow 3 per metre/40in)
 S/Steel finish
 L20/W29.1/H28.8mm
 L0.79/W1.15/H1.13"

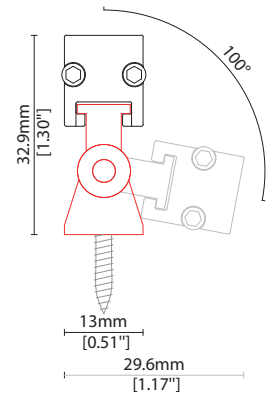

KKBK-05
 Adjustable bracket
 (allow 2 per metre/40in)
 S/Steel finish
 W13/H32.9mm
 W0.51/H1.3"

POWER FEED

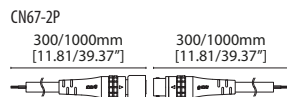

CN67-2P-0300 300mm (11.81in) pair
CN67-2P-1000 1000mm (39.37in) pair
 IP67
 2 PIN male + female connector set



CN67-2P-3000 3000mm (118.11in) pair
 IP67
 2 PIN male + female connector set

Linear

MIMI A020 (20W)

Accessories

KKDÖ

EXTERIOR JUNCTION BOXES



KKJB-07

IP67 Slim J-Box
(including type A,B,C, D bushings)



KKJB-07R

Potting resin for IP67 Slim J-Box

Linear

MIMI A020 (20W) Accessories

KKDÖ

KKDC CONTROL



IP20
Plastic housing
L170/W59/H29mm
(L6.69/W2.32/H1.14in)

KKDM-06 1-10V

visDIM dimmable sub-controller
(4 x 8A max @ 12-36V)



IP20
Plastic housing
L170/W53.4/H28mm
(L6.69/W2.10/H1.10in)

KKSC-05 DMX

visDIM dimmable sub-controller
(4 x 5A max @ 12-36V)



IP20
Plastic housing
L170/W59/H29mm
(L6.69/W2.32/H1.14in)

KKDL-02 DALI

visDIM dimmable sub-controller
(4 x 8A max @ 12-36V)



IP20
Plastic housing
L166/W53.4/H23mm
(L6.54/W2.10/H0.91in)

KKDL-03 DALI

visDIM dimmable sub-controller
(4 x 5A max @ 12-36V)



IP20
Plastic housing
L170/W53.4/H28mm
(L6.69/W2.10/H1.10in)

KKDL-04 DALI-2

visDIM dimmable sub-controller
(4 x 5A max @ 12-36V)



IP20
Plastic housing
L170/W53.4/H28mm
(L6.69/W2.10/H1.10in)

visDIM PRO 30 DALI-2

30kHz PWM Frequency
visDIM dimmable sub-controller
(4 x 5A max @ 12-36V)

AVAILABLE PSU OPTIONS

Control Mode	PSU (Order Code)	Input Voltage AC	Output Voltage DC	Rated Output Current	Rated Power	Dim %	IP Rating
Switched	CEN-60-24	90-295V	24V	2.5A	60W	-	IP67
	HLG-60H-24	90-305V	24V	2.5A	60W	-	IP67
	HLG-100H-24	90-305V	24V	4.0A	100W	-	IP67
	HLG-150H-24	90-305V	24V	6.3A	150W	-	IP67
	HLG-240H-24	90-305V	24V	10A	240W	-	IP67
0-10V (1-10V)	PWM-40-24	90-305V	24V	1.67A	40W	100-0.15 (100-10)	IP67
	PWM-60-24	90-305V	24V	2.5A	60W	100-0.15 (100-10)	IP67
	PWM-90-24	90-305V	24V	3.67A	90W	100-0.15 (100-10)	IP67
	PWM-120-24	90-305V	24V	5.0A	120W	100-0.15 (100-10)	IP67
DALI	LIN100A1	120-277V	24V	1A per channel	100W	100-0.1	IP66/IP40
DMX RGB	LIN100A1	120-277V	24V	1.33A per channel	100W	100-0.1	IP66/IP40
DMX RGBW	LIN100A1	120-277A	24V	1A per channel	100W	100-0.1	IP66/IP40

Flicker Free Options - Combination of PSU+ sub-controller

Control Mode	PSU (Order Code)	Sub-controller (Order Code)	Input Voltage AC	Output Voltage DC	Rated Output Current	Rated Power	Dim %	IP Rating PSU/ Sub-controller
0-10V or 1-10V	CEN-60-24	KKDM-06	90-295V	24V	2.5A	60W	100-0.9	IP67/IP20
	HLG-60H-24	KKDM-06	90-295V	24V	2.5A	60W	100-0.9	IP67/IP20
	HLG-100H-24	KKDM-06	90-295V	24V	4.0A	100W	100-0.9	IP67/IP20
	HLG-150H-24	KKDM-06	90-295V	24V	6.3A	150W	100-0.9	IP67/IP20
	HLG-240H-24	KKDM-06	90-295V	24V	10.0A	240W	100-0.9	IP67/IP20
DALI	CEN-60-24	KKDL-02/03/04/visDIM PRO 30	90-295V	24V	2.5A	60W	100-0.1	IP67/IP20
	HLG-60H-24	KKDL-02/03/04/visDIM PRO 30	90-305V	24V	2.5A	60W	100-0.1	IP67/IP20
	HLG-100H-24	KKDL-02/03/04/visDIM PRO 30	90-305V	24V	4.0A	100W	100-0.1	IP67/IP20
	HLG-150H-24	KKDL-02/03/04/visDIM PRO 30	90-305V	24V	6.3A	150W	100-0.1	IP67/IP20
	HLG-240H-24	KKDL-02/03/04/visDIM PRO 30	90-305V	24V	10.0A	240W	100-0.1	IP67/IP20
DMX RGB	CEN-60-24	KKSC-05	90-295V	24V	2.5A	60W	100-0.9	IP67/IP20
	HLG-60H-24	KKSC-05	90-305V	24V	2.5A	60W	100-0.9	IP67/IP20
	HLG-100H-24	KKSC-05	90-305V	24V	4A	100W	100-0.9	IP67/IP20
	HLG-150H-24	KKSC-05	90-305V	24V	6.3A	150W	100-0.9	IP67/IP20
	HLG-240H-24	KKSC-05	90-305V	24V	10.0A	240W	100-0.9	IP67/IP20

¹ The items shown above cover the most frequently used specification but does not exhaust the possible options

² PSU and/or driver can be chosen from the table, or KKDC may recommend the best option upon receipt of the controls requirement and installation environment

³ Electrical shop drawing will include detailed information of PSU and relevant control drivers

⁴ Cut sheets are available on the controls section of www.kkdc.lighting or upon request